



# LA1186N

## FM Front End for Radio-Cassette Recorders, Music Centers

### Features and Functions

- Contains RF amplifier, MIX, OSC, AFC diode.
- Operating voltage : 1.8 to 8.0V.
- Improvement in cross modulation characteristic due to the use of double-balanced MIX.
- Improvement in strong input characteristic.
- Minimum number of external parts required.
- Less spurious radiation from local OSC.
- TV (1 to 12 channel) receive capability.

### Package Dimensions

unit: mm

#### 3017C-SIP9

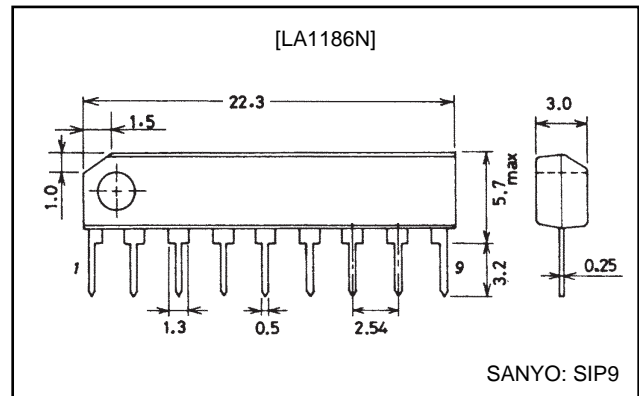

### Specifications

#### Maximum Ratings at Ta=25°C

Parameter	Symbol	Conditions	Ratings	Unit
Maximum supply voltage	V <sub>CC</sub> max		8.0	V
Maximum pin voltage	V <sub>3-5</sub>		12	V
	V <sub>6-5</sub>		V <sub>CC</sub> +0.8	V
Allowable power dissipation	P <sub>d</sub> max	T <sub>a</sub> ≤80°C	150	mW
Operating temperature	T <sub>opr</sub>		-20 to +80	°C
Storage temperature	T <sub>stg</sub>		-40 to +125	°C

#### Operating Conditions at Ta=25°C

Parameter	Symbol	Conditions	Ratings	Unit
Recommended supply voltage	V <sub>CC</sub>		4.5	V
Operating voltage range	V <sub>CC</sub> op		1.8 to 7.5	V

#### Electrical Characteristics at Ta=25°C, V<sub>CC</sub>=4.5V, f<sub>r</sub>=108MHz, f<sub>OSC</sub>=118.7MHz, See specified Test Circuit.

Parameter	Symbol	Conditions	Ratings			Unit
			min	typ	max	
Current dissipation	I <sub>CC</sub>	Quiescent		7.0	9.5	mA
Output saturation voltage	V <sub>o</sub>	V <sub>IN</sub> =100dBμ	95	115	135	V
Local OSC voltage	V <sub>OSC</sub>	V <sub>CC</sub> =2V	200	315		mVrms
Oscillation stop voltage				1.4	1.8	V

# LA1186N

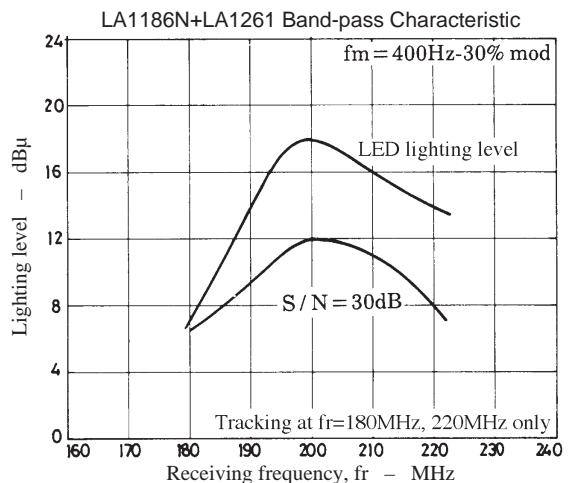
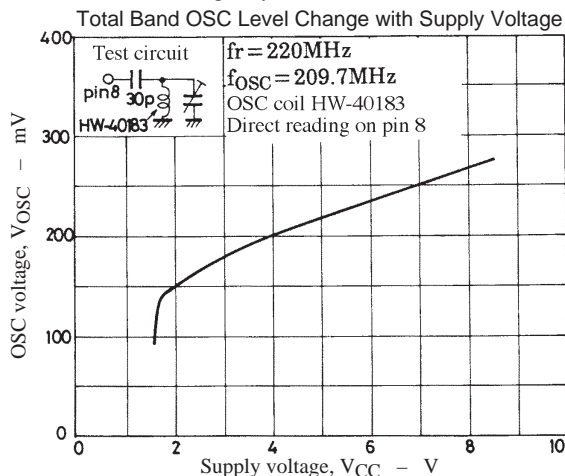
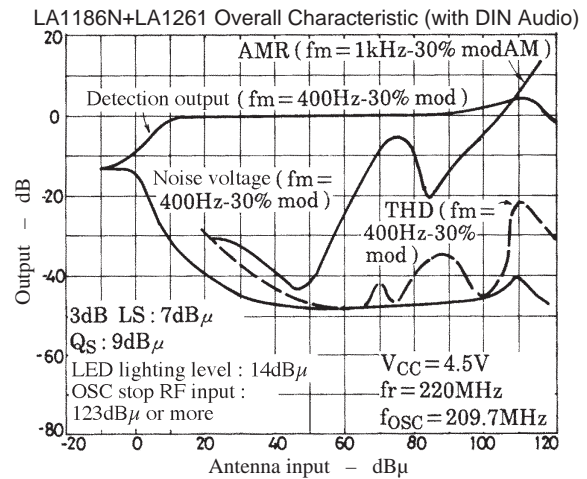
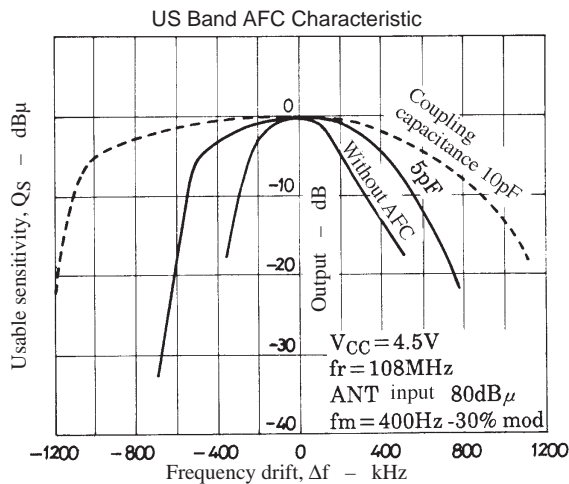
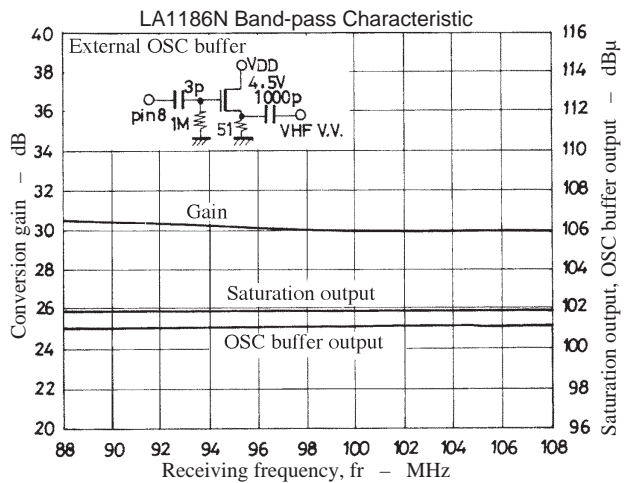
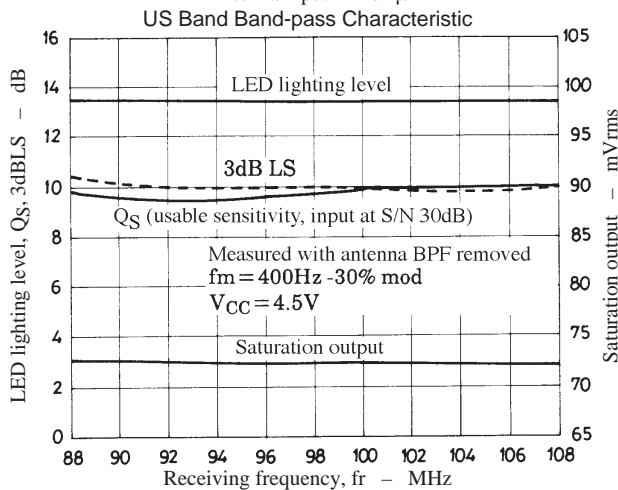
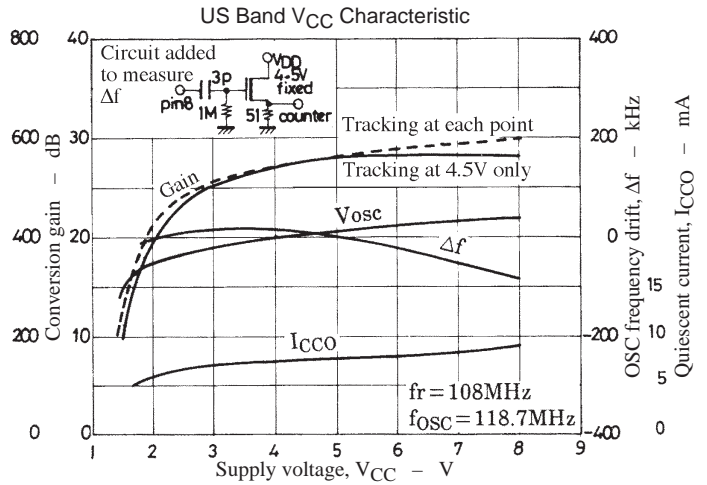
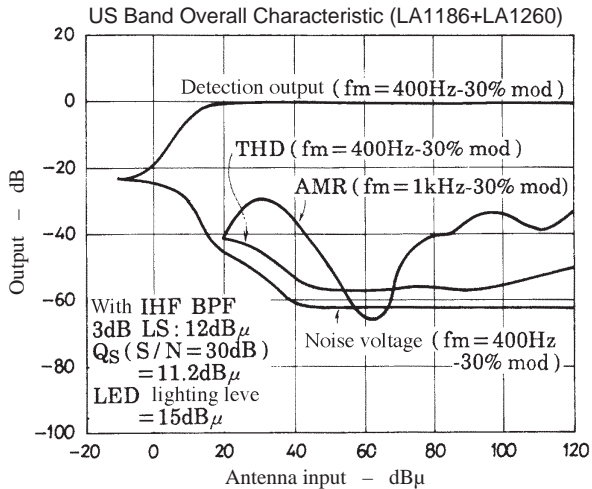

# LA1186N

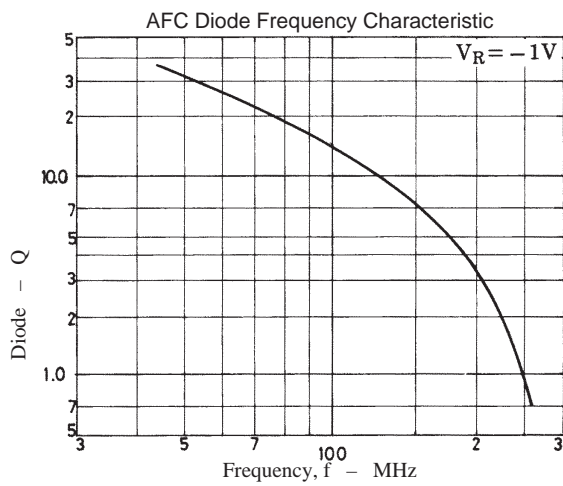
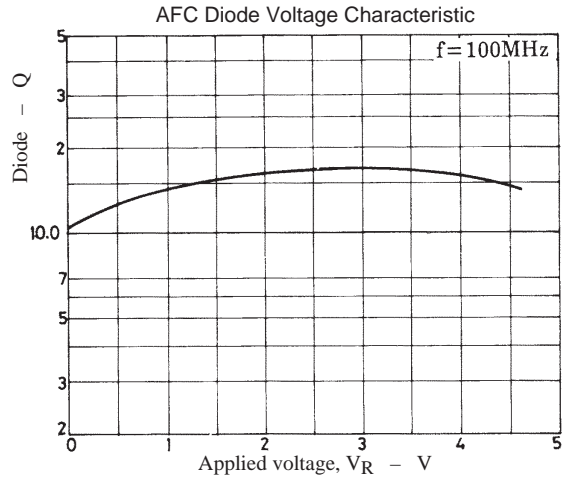
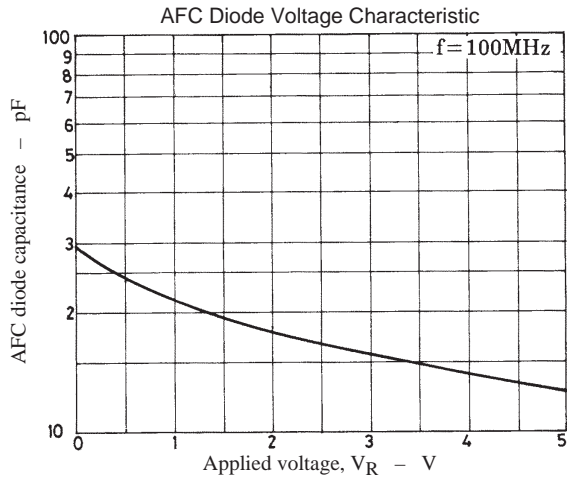

## US Band Test Circuit

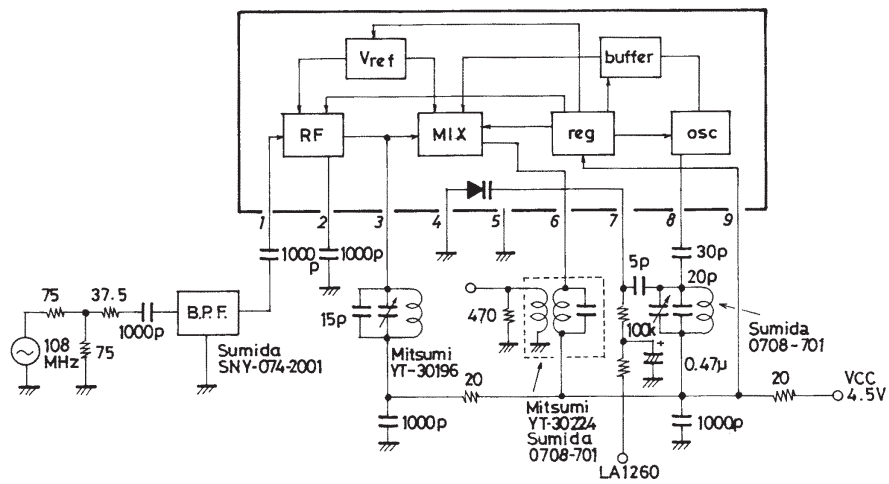



# LA1186N

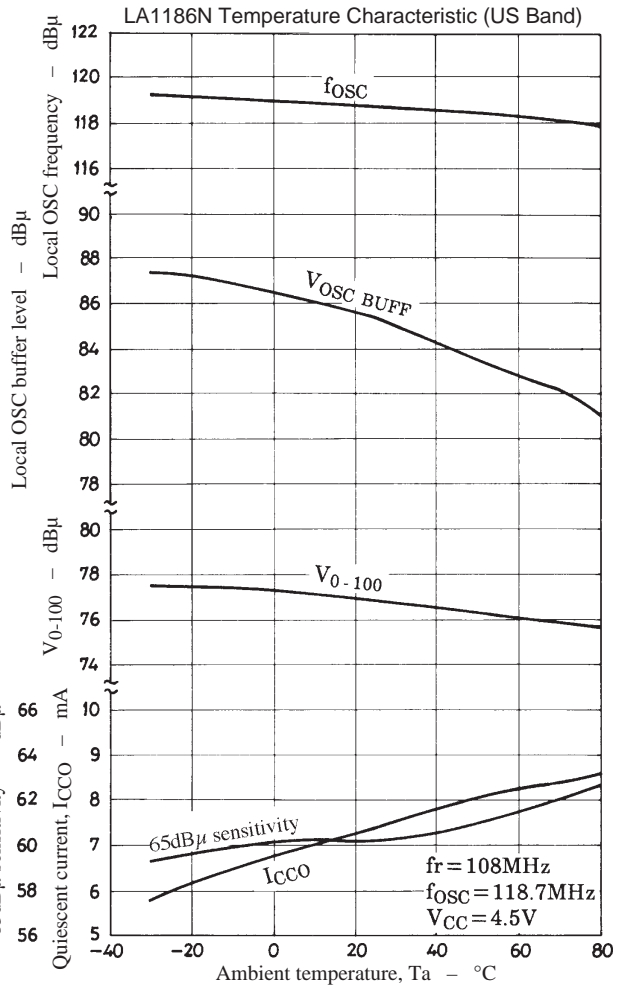
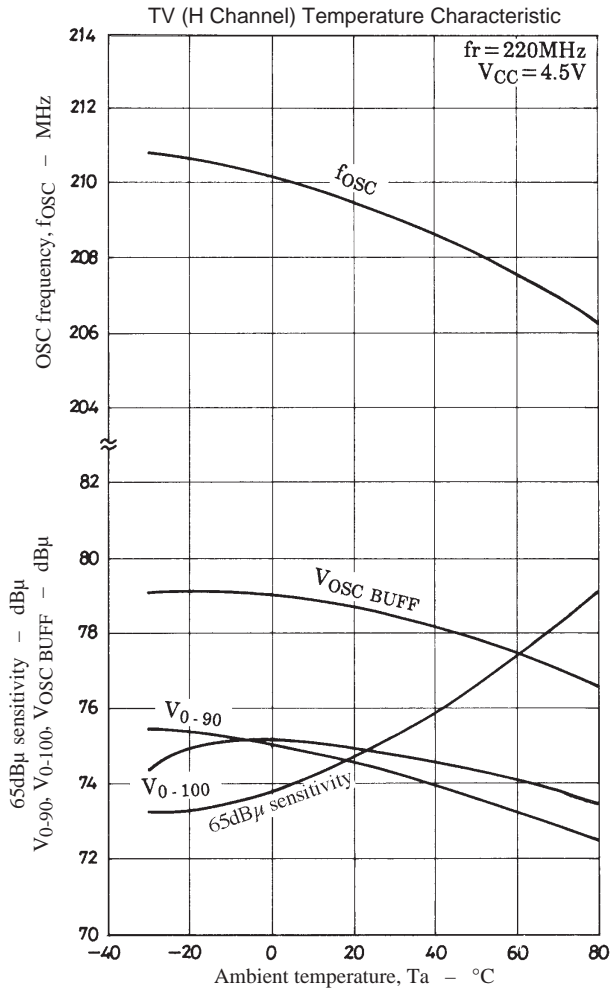

(Note) 65dB $\mu$  sensitivity : Input at 65 dB $\mu$  in Temperature Characteristic Test Circuit

- No products described or contained herein are intended for use in surgical implants, life-support systems, aerospace equipment, nuclear power control systems, vehicles, disaster/crime-prevention equipment and the like, the failure of which may directly or indirectly cause injury, death or property loss.
- Anyone purchasing any products described or contained herein for an above-mentioned use shall:
  - ① Accept full responsibility and indemnify and defend SANYO ELECTRIC CO., LTD., its affiliates, subsidiaries and distributors and all their officers and employees, jointly and severally, against any and all claims and litigation and all damages, cost and expenses associated with such use:
  - ② Not impose any responsibility for any fault or negligence which may be cited in any such claim or litigation on SANYO ELECTRIC CO., LTD., its affiliates, subsidiaries and distributors or any of their officers and employees jointly or severally.
- Information (including circuit diagrams and circuit parameters) herein is for example only; it is not guaranteed for volume production. SANYO believes information herein is accurate and reliable, but no guarantees are made or implied regarding its use or any infringements of intellectual property rights or other rights of third parties.

This catalog provides information as of October, 1997. Specifications and information herein are subject to change without notice.